

**ALFA**

**USER MANUAL**  
FORNO NAPOLI





<b>INITIAL LIGHTINGS.....</b>	<b>2</b>
<b>WARNINGS.....</b>	<b>4</b>
<b>ASSEMBLY AND INSTALLATION.....</b>	<b>8</b>
<b>PLACEMENT.....</b>	<b>9</b>
<b>CONTROL UNIT ASSEMBLY.....</b>	<b>10</b>
<b>GAS BURNER ASSEMBLY.....</b>	<b>12</b>
<b>OVEN INSTALLATION.....</b>	<b>14</b>
<b>WOOD IGNITION.....</b>	<b>16</b>
<b>15 kW BURNER.....</b>	<b>18</b>
<b>34 kW BURNER.....</b>	<b>24</b>
<b>CARE AND MAINTENANCE.....</b>	<b>37</b>
<b>WARRANTY.....</b>	<b>38</b>

# BE CAREFUL WHEN FIRST TIME LIGHTING

## WOOD

**WARNING: Before turning on the oven, follow the instructions below.**

- Do not use flammable liquids or other fuels to turn on the oven.
- Make sure that there are no flammable materials in the vicinity of the oven and that the minimum installation distances are respected.
- Care and attention during the initial lightings is aimed at preventing thermal shock that could damage the refractory stone.
- Read the following information carefully for the correct installation and optimal functioning of the oven.

## INITIAL LIGHTINGS

After installation wait 3 days before turning on the oven. The initial days of ignition will serve to dry all parts of the oven from the humidity that is generated during production.

### - **FIRST DAY**

Use the utmost caution on the first day of ignition. Do not exceed **100°C** and maintain this temperature for as long as possible (minimum 50/60 minutes). A flame obtained from twigs is recommended.

### - **SECOND DAY**

Use the utmost caution on the second day of ignition. Do not exceed **100°C** and maintain this temperature for as long as possible (minimum 50/60 minutes). A flame obtained from twigs is recommended.

### - **THIRD DAY**

Do not exceed **200°C** on the third day of ignition and maintain this temperature for as long as possible (minimum 50/60 minutes). The use of small-cut wood is recommended.

### - **FOURTH DAY**

Reach a maximum temperature of **300°C** using small pieces of wood and maintain this temperature for as long as possible.

### - **FIFTH DAY**

On the fifth day you can turn on the oven and start cooking the pizzas; the refractory material will have completely dried.



**WARNING: DURING THE INITIAL DAYS OF IGNITION THERE MAY BE A SPILLAGE OF WATER FROM THE OVEN STRUCTURE; THIS IS NORMAL AND OCCURS DUE TO THE POSSIBLE PRESENCE OF MOISTURE INSIDE THE REFRACTORY STONE.**



# BE CAREFUL WHEN FIRST TIME LIGHTING

## GAS

**Before starting the burner, it is necessary to carry out the appropriate preliminary checks to avoid malfunctions or damage to the machine itself**

- check that the mouth door is open;
- check that all the taps on the gas system are open;
- check the correct connection of all electrical conductors;
- check that the protective steel cap on top of the burner has been removed;
- check that there are no leaks in the gas system;
- check the gas pressure on the general outlet of the burner;

## INITIAL LIGHTINGS

After installation wait 3 days before turning on the oven. The initial days of ignition will serve to dry all parts of the oven from the humidity that is generated during production.

### - **FIRST DAY**

Use the utmost caution on the first day of ignition. Do not exceed **100°C** and maintain this temperature for as long as possible (minimum 50/60 minutes).

### - **SECOND DAY**

Use the utmost caution on the second day of ignition. Do not exceed **100°C** and maintain this temperature for as long as possible (minimum 50/60 minutes).

### - **THIRD DAY**

Do not exceed **200°C** on the third day of ignition and maintain this temperature for as long as possible (minimum 50/60 minutes).

### - **FOURTH DAY**

Reach a maximum temperature of **300°C** using small pieces of wood and maintain this temperature for as long as possible.

### - **FIFTH DAY**

On the fifth day you can turn on the oven and start cooking the pizzas; the refractory material will have completely dried.



**WARNING: DURING THE INITIAL DAYS OF IGNITION THERE MAY BE A SPILLAGE OF WATER FROM THE OVEN STRUCTURE; THIS IS NORMAL AND OCCURS DUE TO THE POSSIBLE PRESENCE OF MOISTURE INSIDE THE REFRACTORY STONE.**

# WARNINGS

## PLEASE KEEP THIS MANUAL FOR FUTURE REFERENCE

Online copies of this manual are available at [www.alfaforni.com](http://www.alfaforni.com)

**PLEASE READ THE FOLLOWING INFORMATION CAREFULLY FOR CORRECT INSTALLATION AND USE OF THE OVEN. THIS APPLIANCE, IF NOT PROPERLY INSTALLED AND USED, CAN CAUSE FIRE. TO REDUCE FIRE HAZARDS, FOLLOW THE INSTRUCTIONS AND USE MATERIALS SPECIFICALLY DESIGNED TO WITHSTAND HIGH TEMPERATURES.**

- Cracks inside and outside the oven refractory materials may occur as a result of thermal shock and don't compromise the functionality of the appliance.
- In case of long periods of inactivity, follow the instructions as if it were the first use.
- The oven door is an effective temperature regulator: by closing it and opening it you can manage the heat.
- During use, refractory ovens can get very hot
- Use high-temperature cutlery and tools.
- For safety reasons, keep the oven out of reach of children and pets.
- Put the oven on a flat surface and away from wind or strong draughts.
- Sparks may come out of the oven mouth: make sure not to put flammable liquids near it.
- Do not touch the flue and the door when the oven is operating to avoid burns.
- Do not use the oven in case of breakage or malfunctioning.
- Hold the door handle when opening and closing.
- The oven colour may change owing to the temperature.
- Do not use water to put out the fire.
- Do not use flammable liquids close to the oven.
- Do not colour the oven or stick objects on it.
- Do not use any fuel other than that recommended.
- Do not ignite the oven abruptly to avoid damage to refractory materials.
- At 100°C (212°F) water/humidity of the oven turns into steam. In this process, water increases its volume 30 times and can seriously damage the refractories if the ignition is not gradual.
- Do not bend over the oven during ignition: keep face and body away from the oven door.
- Do not leave the appliance unattended during cooking releasing fats and oils: they can catch fire.
- Do not obstruct ventilation openings.
- Wear heat resistant gloves when operating the oven.



# WARNINGS

ONLY FOR WOOD-FIRED OR HYBRID OVENS

**Do not throw logs on the fire but lay them on it**

Do not make a big fire that comes out of the oven mouth

**Do not use any fuel other than firewood**



# WARNINGS

## ONLY FOR GAS-FIRED OVENS

**GAS LEAKS CAN LEAD TO FIRES AND EXPLOSIONS AND CAN CAUSE SERIOUS PROPERTY DAMAGES, PERSONAL INJURIES AND DEATH.**

### **WHAT TO DO IF YOU SMELL GAS:**

1. Turn off the gas supply
2. Extinguish any naked flame
3. Open the oven door
4. Call a gas service technician

WARNING: this oven may be converted from natural gas to LPG and vice versa by means of the kit supplied by Alfa Forni; conversion must be carried out by specialised technicians using Alfa material, otherwise, the warranty will no longer be valid.

The product must be installed by qualified personnel.

- If the gas-fired oven is not being used, switch off the gas supply.
- Follow the instructions to connect the gas regulator.
- If the oven is left inactive for a certain period, make sure there are no gas leaks and that the burners are not clogged.
- Keep power cables and supply pipes away from hot surfaces.
- No flammable materials may be kept within a 1-metre radius of the oven.
- In case of uncontrolled fire, move the food away from the flames until they are smothered.
- If the fat catches fire, shut off the gas valve and close the door until the fire goes out.
- LPG is not the same as natural gas. It's dangerous to convert or use natural gas with an oven powered by LPG. In this case, the warranty will be invalid.
- A rusty or damaged gas bottle may be dangerous and should be checked by the supplier. Do not use gas bottles with faulty valves.
- Do not place used gas bottles near the oven. Non-empty containers may still contain traces of combustible material.
- This appliance is intended for professional use by qualified persons. Do not allow children to come near the oven when in operation or to play with it.







# ASSEMBLY AND INSTALLATION OF THE BASE

IF YOU ALSO BUY THE OVEN BASE, JUST PLACE THE OVEN ON IT AS SHOWN IN THE PICTURE.



## STEP 1

Lift the oven with the help of a forklift paying attention to its load capacity that usually ranges from 1 200 to 2 200 kg (2 600 to 5 000 lbs).



## STEP 2

Lift the oven over the base and place it carefully on it.

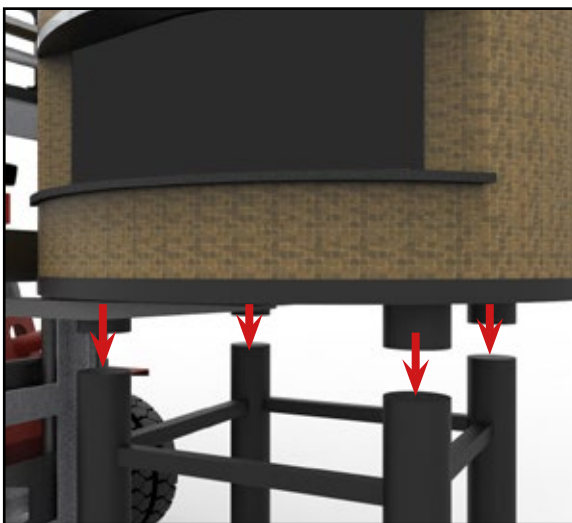

## STEP 3

Fit the oven legs with the base structure.

# PLACEMENT



**WARNING: THE EXTERNAL SIDES OF THE OVEN CAN REACH TEMPERATURES ABOVE 50°C (120°F). ANY FLAMMABLE MATERIALS MUST NOT BE WITHIN 1-METRE RADIUS OF THE OVEN.**

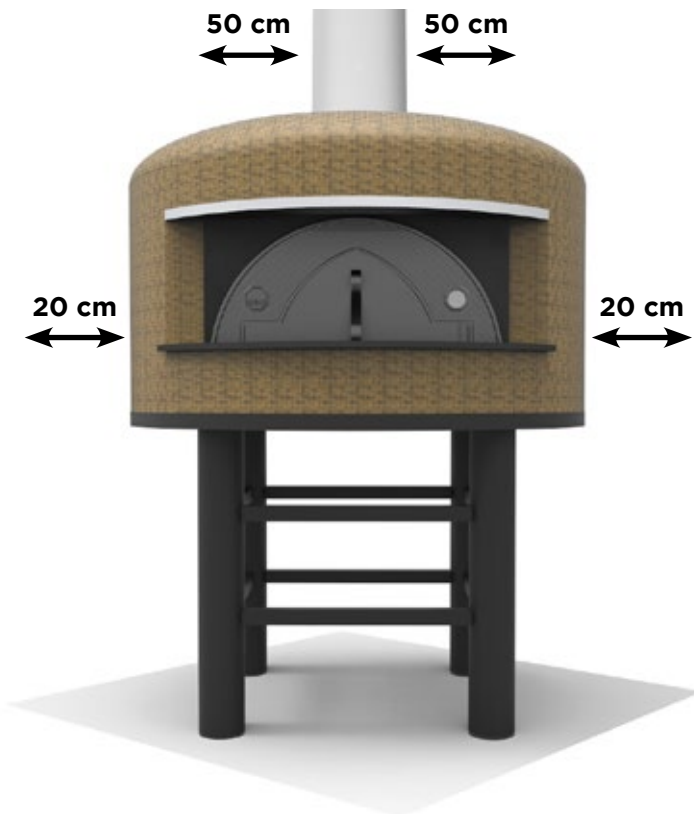

**CAUTION: Put the oven away from wind or strong draughts.**

**The Napoli built-in oven is available. In gas-fired models, allow for a ventilation and inspection grid for the burner.**

**FOR YOUR SAFETY: Place the oven on a flat and stable surface. Involuntary movements during operation may result in personal injury and property damage.**

**Consider a minimum distance of 50 cm (20 in) to place the flue according to the model and insulation.**

**CAUTION: Place the oven at a minimum distance of 20 cm (8 in) from the wall or any other equipment.**

**Never place firewood or flammable materials on the oven landing.**

# CONTROL UNIT ASSEMBLY

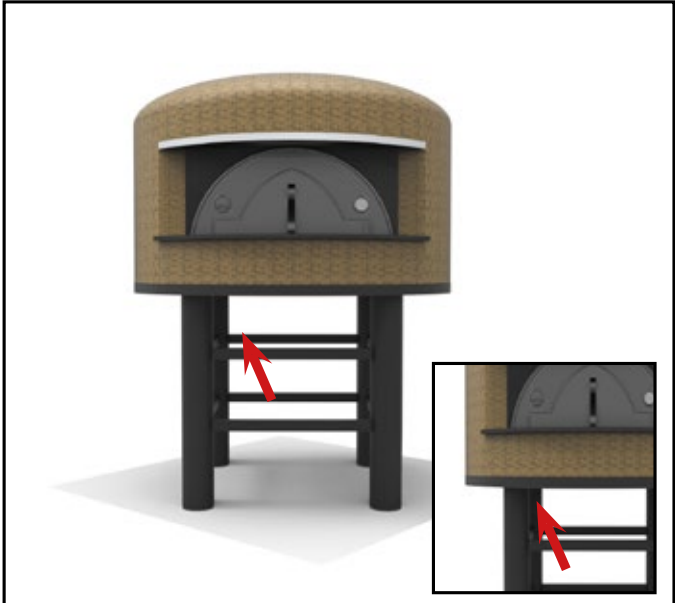

**Control unit**

- 1. 5-pin Multipolar connector
- 2. 4-Pin Multipolar connector
- 3. Electrical socket
- 4. Temperature probe

**1 -** Position the control unit at the prearranged point indicated by the arrow in the image.



**2 -** Once the burner is in place attach the control unit to the base crossbar using self-drilling screws or a drill

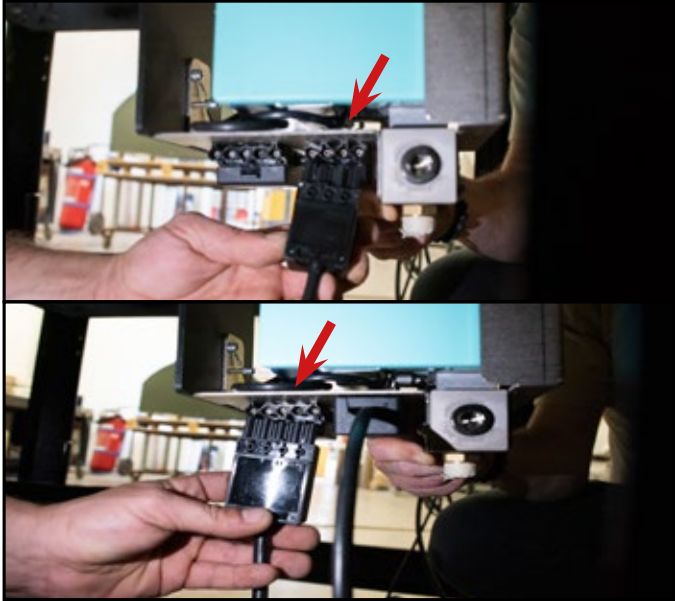

**3 -** Connect the two multipolar connectors into the sockets located on the back of the burner.



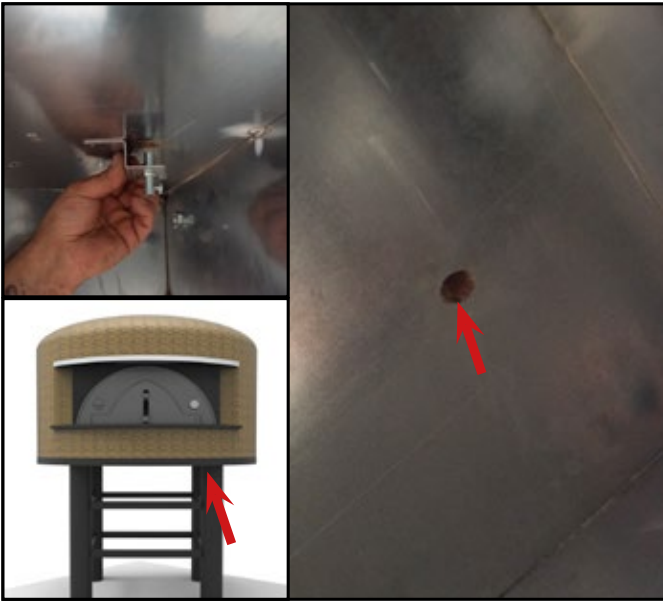

**4** - Secure the probe lock bracket in the hole under the oven on the right side



**5** - Insert the probe into the hole so that it protrudes 1cm on the refractory surface.

# GAS BURNER ASSEMBLY

15kw -34kw

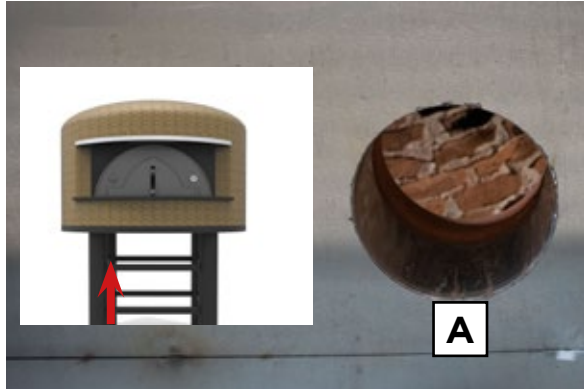

## STEP 1

The refractory floor of the Napoli oven is already set up to house the burner.

Looking under the oven, on the left side, you can locate the connection hole (A).

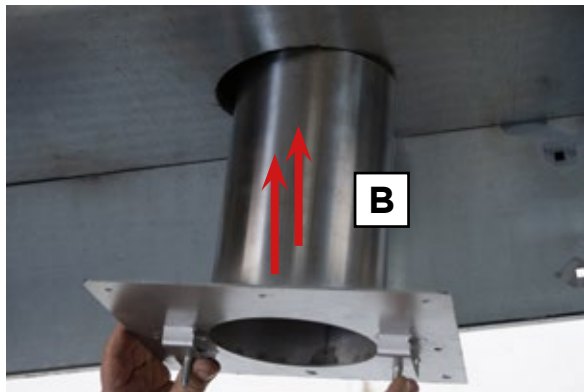

## STEP 2

Insert the supplied sleeve (B) inside the hole, necessary to connect the burner.



## STEP 3

After positioning the sleeve, secure it to the structure using the the prearranged fastening.

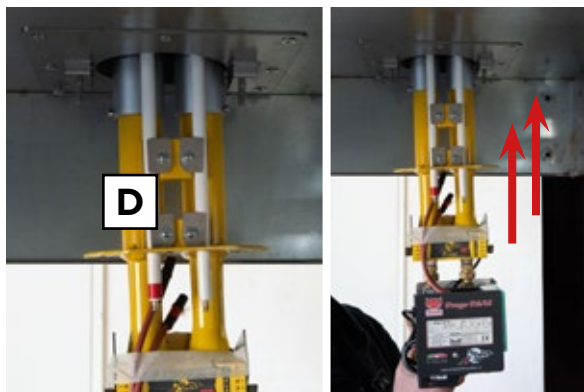

## STEP 4

Insert the burner (D) into the sleeve just installed.

We recommend that you do this with 2 people.



### STEP 5

Use the nut and washer (E) supplied to secure the burner to the sleeve.

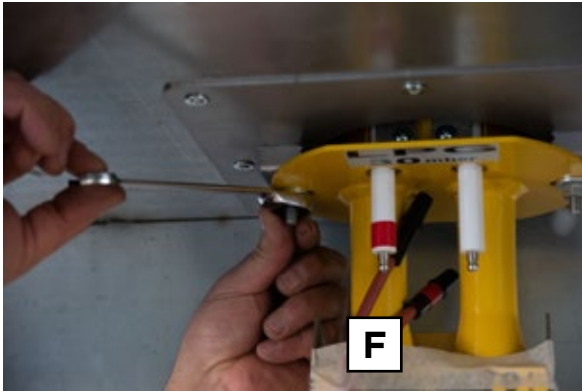

### STEP 6

Use a size 13 wrench to tighten the nuts.

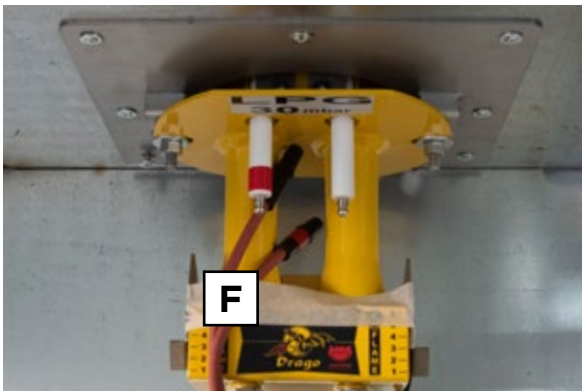

### STEP 7

Once the two nuts with the relative washers have been tightened, the burner is fixed to the oven and the electric cables (F) can be connected to the control unit.



# OVEN INSTALLATION

**IN THE EYES OF THE LAW, THE FLUE MUST SERVE ONLY ONE APPLIANCE. CONNECTING MANY OVENS TO THE SAME FLUE COULD COMPROMISE A REGULAR EVACUATION OF SMOKE.**

**Contact local fire services to find out about any restrictions regarding flue installation or inspection of oven installation.**

## INDOOR FLUE CONNECTION

For the Napoli oven to function correctly, it needs a flue with a diameter of 250 mm (10 in) and at least 4 metres (13 ft) high.

1. For existing and insufficient flues, it is advisable to use stainless steel connecting pipes with right diameter and proper insulation.
2. Seal with materials resistant to high temperatures (450°C-840°F).
3. This connection must avoid as far as possible any bends or diversions that can prevent the smoke evacuation.
4. Any bend must be no greater than 45 degrees.
5. To prevent smoke from travelling back into your home, place the chimney pot in the highest part of the roof fully exposed to the wind (anti-downdraught chimney cowls).
6. Do not connect the flue with other ducts.
7. The flue must be thermally insulated to prevent heat loss and to allow the smoke to rise.
8. All installation work must be carried out by an authorized expert.
9. The following table shows the correct diameter (D) of the flue as its height varies.

H < 3 m	3 m < H < 5 m	H > 5 m
D 300 mm	D 250 mm	D 200 mm

**N.B.** A butterfly valve, not included, can improve the draught and smoke regulation.

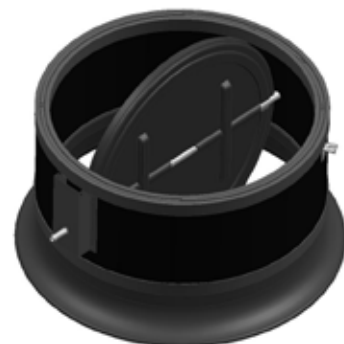



## **PYROMETER**

- The pyrometer detects the temperature at a given point inside the oven. The value gauged by the pyrometer is only indicative. With experience, you will better assess when the oven is ready for various types of cooking. Gradually, you will have command of your oven and become very adept at choosing the cooking temperature. The Alfa Pro laser thermometer comes as an optional extra in the tool section of the website.



## **OVEN DOOR**

- If the fire is too high and spills out of the oven mouth, use the door to adjust the flame.

**WARNING:** this product has not been tested for use with the door. To reduce the risk of fire and injuries, do not use the oven door.

Keep the oven door open when the fire is on.

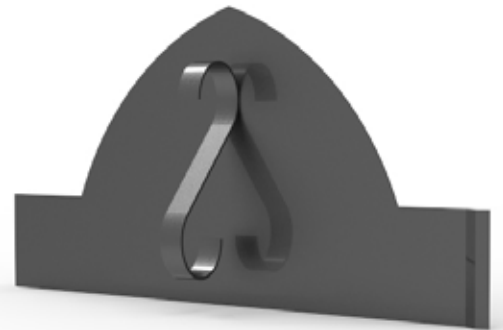

## **PUTTING OUT THE FIRE**

To extinguish the fire, close the oven door and wait for the ash to form. Make sure the oven is cold and remove the ash with the help of metal tools.

# IGNITION

## WOOD-FIRED OVENS

**WARNING: Before firing the oven, follow the instructions.**

- Do not use flammable liquids or other fuels to light the fire.
- Make sure that there are no flammable materials near the oven and that the minimum safety distance is respected.

### IGNITION

1. Make a small pile of dry kindling in the centre of the oven.
2. When the fire gets going, add two large logs and move the fire to one side of the oven.
3. After a few minutes of continuous burning, the oven will reach the temperature of 400°C (750°F) burning soot. Now the oven is ready to cook.



### PUTTING OUT THE FIRE

- To extinguish the fire, close the oven door and wait for ash to form
- After about 30 minutes, remove the ash.

### DIFFERENT TYPES OF FIREWOOD

- Use small-sized dry wood for lighting the fire.
- Never use treated, resinous or scrap wood to make the fire.
- Wet or damp wood can pop due to the water trapped inside. It will produce a lot of smoke and less heat.

### FOR YOUR SAFETY:

- **Do not leave the oven unattended while the fire gets going**
- **To keep constant temperature, throw in small amounts of firewood at regular intervals. Do not keep adding more logs to avoid a dangerous rise in temperature or flames spilling out of the oven that could damage people or things.**





# 15 kW BURNER

## NAPOLI OVEN MODEL M90

**WARNING: Before firing the oven, follow the instructions.**

- Check all gas connections before using the oven
- Do not lean over the oven when lighting. Keep your face and body at least 50 cm (20 in) away from the oven door.
- When lighting the oven, the door must be open.
- The gas knob must be in the "0" position.
- Do not move the oven when it is in use.

1. To ignite the pilot light, press and turn the knob to the spark symbol.

2. Press the gas knob and the ignition button at the same time to spark the pilot light.





**N.B.** The ignition of the pilot light might need several attempts due to the air in the supply line, so be patient.

3. Once the pilot light is on, release the ignition button but **KEEP PRESSING** the burner knob for at least 15 seconds to allow the thermocouple to heat up enough.



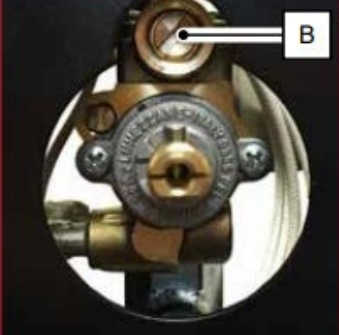

4. Release the gas knob and turn it anticlockwise to high flame setting to heat up the oven.



# HIGH FLAME ADJUSTMENT

STEP	ACTION	PICTURE
1	Press and rotate the selection knob anti-clockwise.	
2	Set the selection knob on the "HIGH FLAME" symbol.	
3	Extract the knob "A" by grasping it with your fingers and pulling it firmly outwards.	
4	Adjust the height of the high flame by actuating the screw "B": <ul style="list-style-type: none"> <li>• tighten to reduce the flame;</li> </ul> The correct flow rate is obtained when the flame reaches the centre of the oven cupola.	
5	Check the flame colour in connection with the air flow. The flame must be soft, silent and yellow, but it must not colour the cupola of the oven: <ul style="list-style-type: none"> <li>• Methane: open the damper to position 3.5/4.</li> <li>• LPG: open the damper to position 5.5/6.</li> </ul>	
6	Once the flame adjustment procedure is completed, refit the knob "A".	

# LOW FLAME ADJUSTMENT

STEP	ACTION	PICTURE
1	Press and rotate the selection knob anti-clockwise	
2	Set the selection knob on the "LOW FLAME" symbol.	
3	Extract the knob "A" by grasping it with your fingers and pulling it firmly outwards.	
4	Adjust the height of the high flame by actuating the screw "C". The flow rate is correct when the flame touches the cupola and the empty oven does not increase in degrees.	
5	Check the flame colour in connection with the air flow. The flame must be soft, silent and yellow, but it must not colour the cupola of the oven: • Methane: open the damper to position 3.5/4. • LPG: open the damper to position 5.5/6.	
6	Once the flame adjustment procedure is completed, refit the knob "A".	

# FLAME AIR JUSTMENT

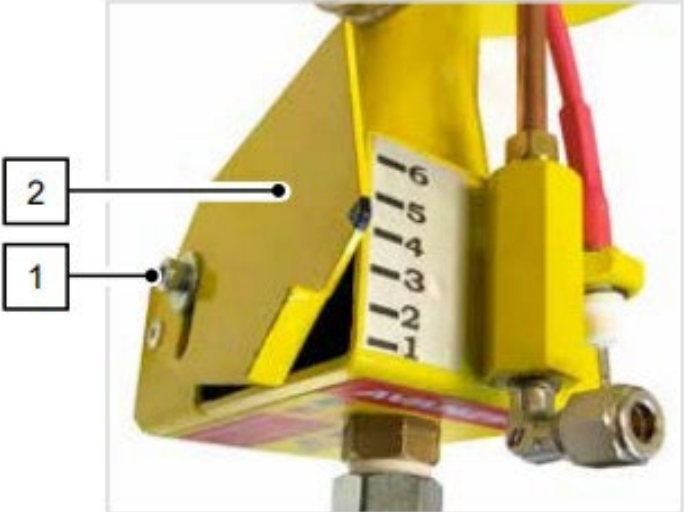
STEP	ACTION	PICTURE
1	The burner must be on	
2	Loosen the hex socket "1" on the air flow adjustment bulkhead of the flame	
3	Manually operate on partition "2" until the desired air flow is obtained.	
4	Check the flame colour in connection with the air flow. NOTE: the flame must be blue at the base and yellow at the tip, just enough to illuminate the oven, but without forming soot (flame too yellow).	

## IMPORTANT!

The colour of the flame indicates the air - gas mixing ratio. A light blue flame indicates that there is too much oxygen. A yellow flame indicates that there is not enough oxygen



# LPG-NATURAL GAS CONVERSION

## NAPOLI GAS BURNER 15KW

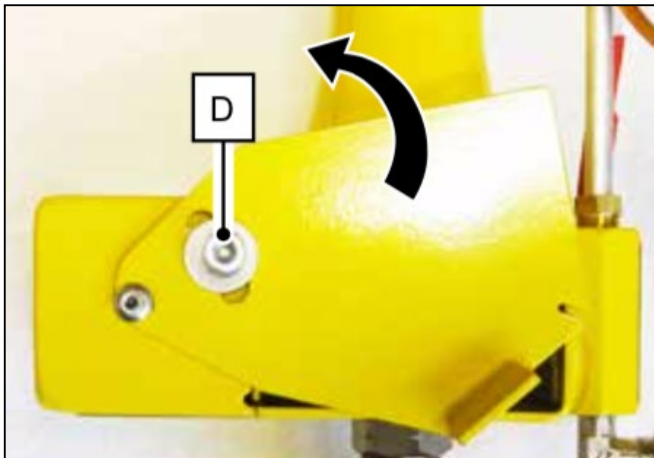

**STEP 1** - Use a  $\varnothing 4$  mm spanner to loosen and remove screw "D" to fully open the partition.

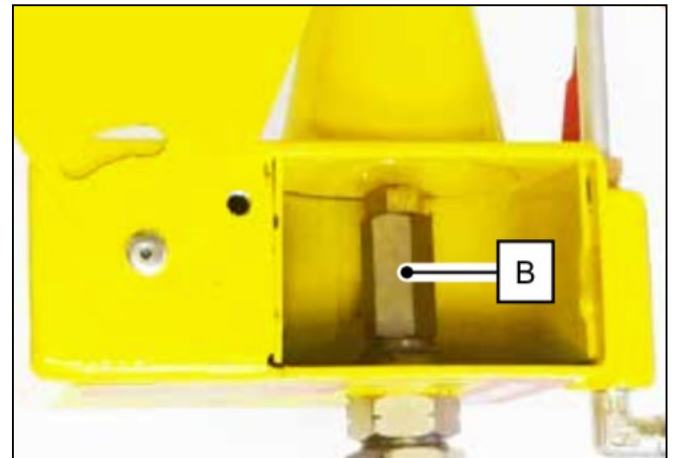

**STEP 2** - Use a 13 mm spanner to dismantle the stud bolt "B" and remove it from the burner.

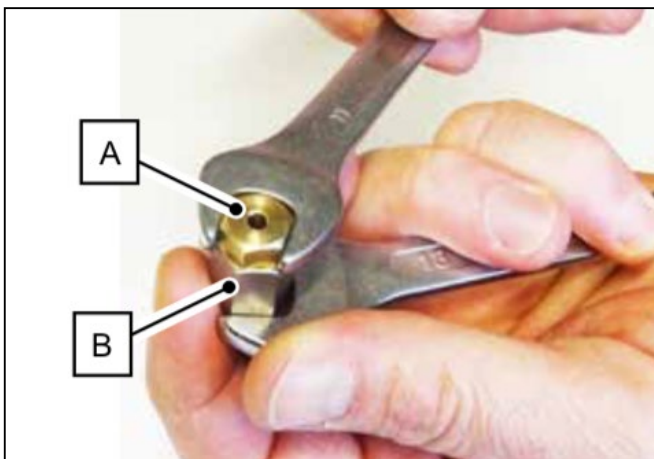

**STEP 3** - Use an 11 mm spanner to unscrew nozzle "A" from stud bolt "B", and replace the nozzle required for the type of gas.

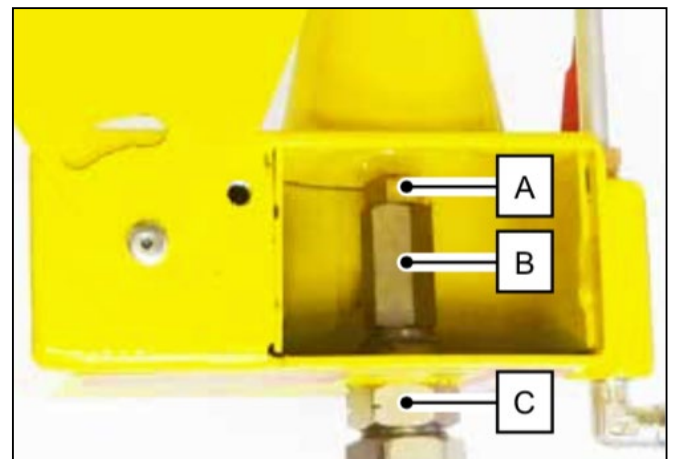

**STEP 4** - Fasten stud bolt "B" and nozzle "A" to fitting "C".

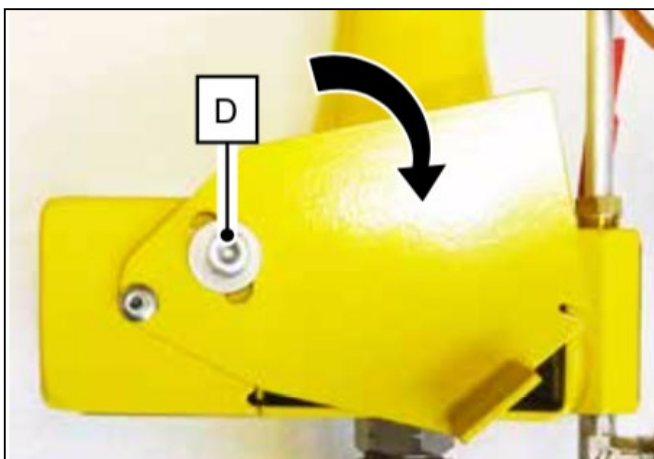



**STEP 5** - Tighten screw "D" again to fasten the partition.



**NAPOLI gas burner 15KW**



# REPLACEMENT SWITCH-ON BATTERY

STEP	ACTION	PICTURE
1	Unscrew and remove the power button "A".	
2	Remove the old battery and insert a new battery in the compartment "B", complying with the polarity.	
3	Tighten the button "A".	
4	Dispose of the replaced battery correctly.	

# 34 kW BURNER

NAPOLI OVEN MODEL M120- M130- M150

## EASY BURNER COMPONENTS

1. Control equipment
2. Multiple 7-pin plug
3. Fuel solenoid valves
4. Pressure tap
5. First flame regulator
6. First flame pressure tap
7. Second flame pressure tap
8. First flame air regulator
9. Second flame air regulator
10. Flame ionization cable
11. Flame ignition cable
12. Flame ionization electrode
13. Flame ignition electrode

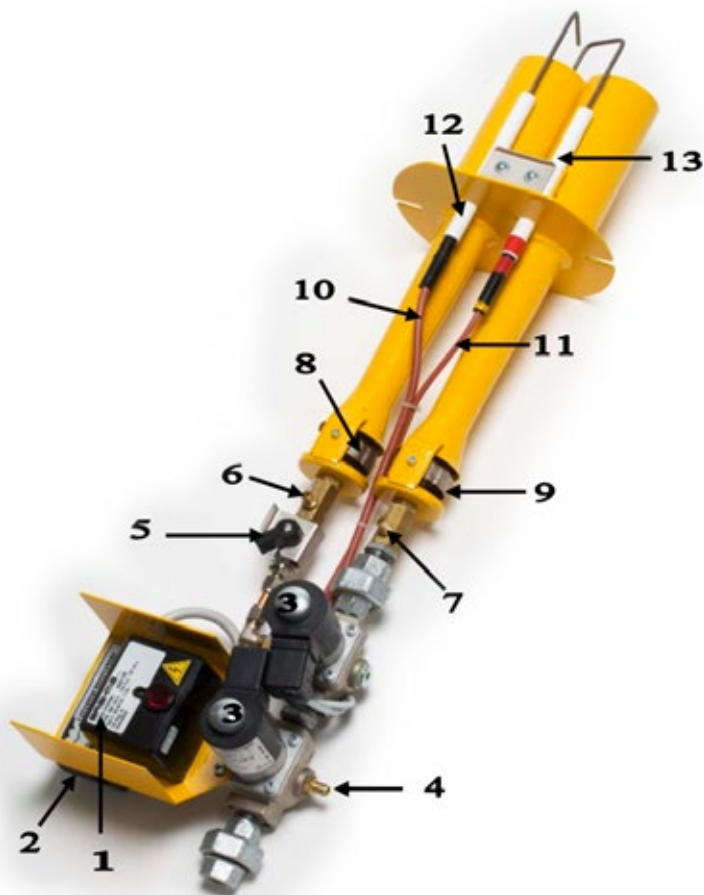

## CONTROL UNIT FUNCTIONS LIST

1. Burner on Switch.
2. Button to increase the power of the second flame F2".
3. Button to reduce the power of the second flame F2.
4. Button to increase the set temperature.
5. Booster function enable/disable button. Button to turn off and on the second flame manually.
6. Button to decrease the set temperature.
7. First flame mode signal LED.
8. F2 second flame operation signal LED.
9. Faulty temperature probe signal LED.
10. Burner block warning LED.
11. Button to "Reset" (unlock) the burner.
12. Read-out (red) of the internal T° measured by the probe and error messages.
13. Read-out (green) of teh set baking T° and control unit information
14. Second flame (F2) power indicator.
15. Main switch.

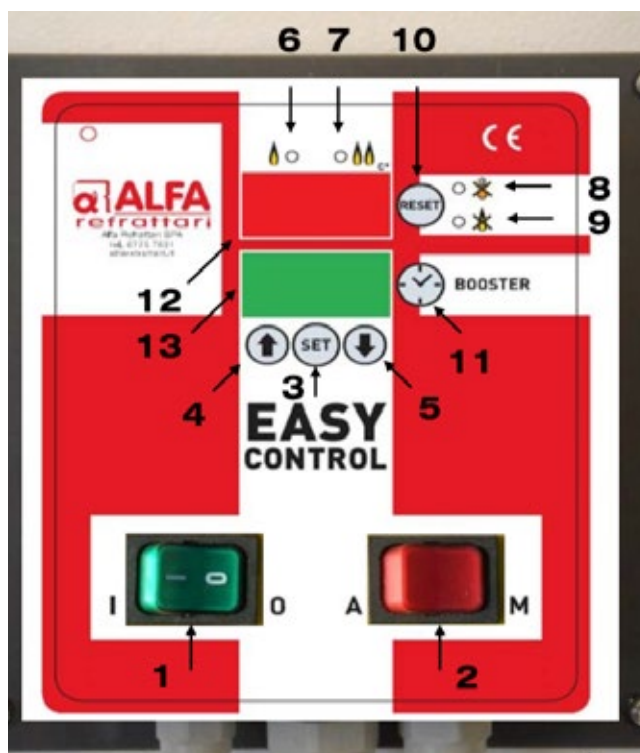

# LPG-NATURAL GAS CONVERSION

## NAPOLI GAS BURNER 34kW

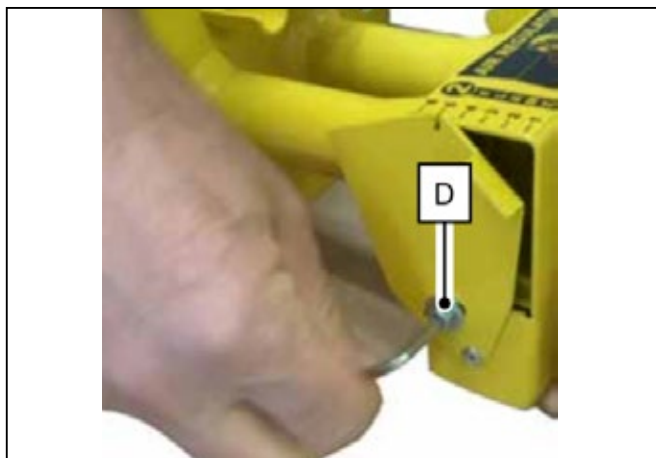

**STEP 1** - Loosen and remove screw "D" to fully remove the partition.

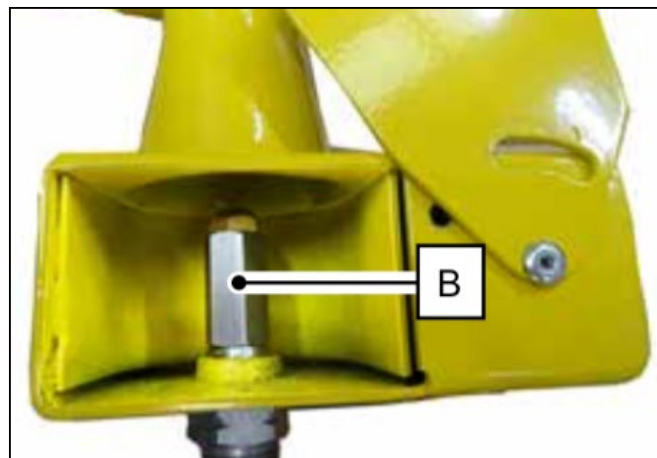

**STEP 2** - Dismantle the stud bolt "B" and remove it from the burner.

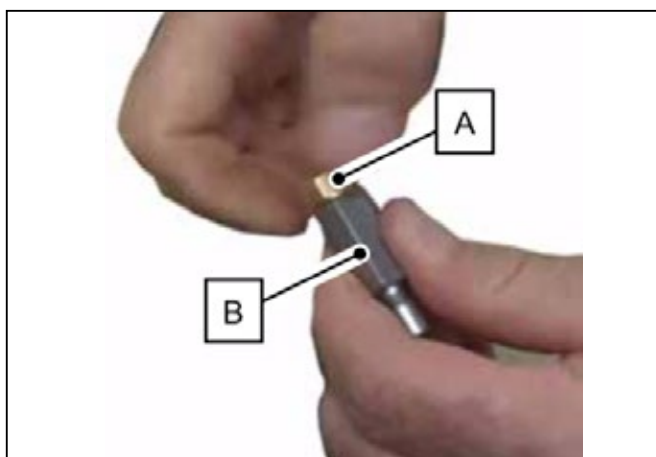

**STEP 3** - Unscrew nozzle "A" from stud bolt "B", replace the nozzle required for the type of gas. Always comply with the flame 1 and flame 2 specifications.

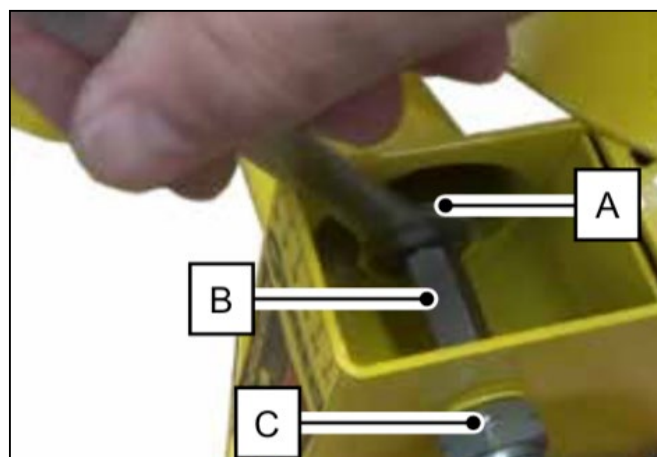

**STEP 4** - Fasten stud bolt "B" and nozzle "A" to fitting "C".

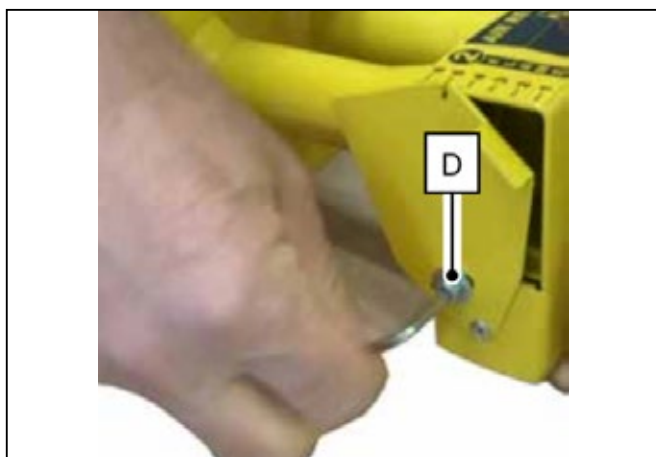



**STEP 5** - Tighten screw "D" again to fasten the partition. The position of the bulkhead regulates the combustion air so be careful to reposition it correctly.



**NAPOLI gas burner 34kW**

# IGNITION

## GAS-FIRED OVENS

STEP	ACTION	PICTURE
1	Press the red "MAIN SWITCH" on the left side.	
-	On the green display "OFF" is displayed and the internal temperature of the oven is displayed on the red display.	
2	Press the red button to ignite the burner in "ON". On the green display the set temperature or zero is displayed.	



### FOR YOUR SAFETY:

- Do not close the door when the oven is on with the flame at the maximum setting.
- Never exceed the temperature limit of 500°C (900°F).
- Never disconnect the gas pipe or other fittings when using the oven.

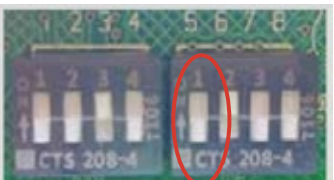
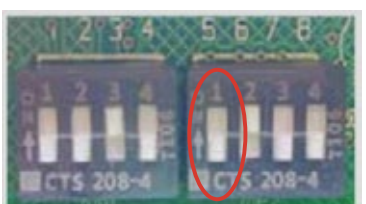

# CHANGE UNIT OF MEASUREMENT

CELSIUS / FAHRENHEIT



STEP	ACTION	PICTURE
1	Disconnect the voltage to the control unit from the main switch inside the room.	
2	Undo the 4 screws to open the Drago Control Plus control panel.	
3	On the back of the control panel identify the terminal block.	
4	Acting on the NO 5 LEVER it is possible to change the degree measurement unit: <ul style="list-style-type: none"><li>• Fahrenheit (°F) degrees are set with the lever in high position.</li><li>• Celsius (°C) degrees are set with the lever in low position.</li></ul>	
5	Tighten the screws to fix the cover of the Drago Control Plus control panel back in place.	

**IT IS STRICTLY FORBIDDEN TO MODIFY THE FUSES WITH WIRINGS OR OTHER CONNECTIONS..**

# TEMPERATURE AND FLAME ADJUSTMENT

THE MAXIMUM SETTABLE TEMPERATURE IS 450 °C

**CAUTION!**  
THE SET COOKING TEMPERATURE F2 IS THE SAME AS THE OVEN OPERATING TEMPERATURE.

STEP	ACTION	PICTURE
1	Press the temperature up button until the temperature to be set shows on the green display. <b>Note: it is rarely necessary to exceed 360°C as set temperature.</b>	
2	When the desired temperature is reached, release the arrow key. The Drago Control Plus stores the set temperature, which flashes on the green display.	
3	The green display stops flashing and the led related to the operation of the second flame switches on igniting the 2nd flame.	



## GAS ADJUSTMENT 1<sup>ST</sup> FLAME (F1)

Flame F1 is always on when the burner is working, and it carries out two functions only:

- cook pizzas in a preheated oven,
- light up the inside of the baking chamber.

Flame F1 DOES NOT have to heat up the oven, as it is a “maintenance” flame.

The oven working in F1 mode only does not have to raise the T°; instead, the temperature has to gradually decrease by 7°C so that the F2, if it is being used, switches on again, or maintain the same temperature if empty.

The flame F1 stays on, to be visually inspected; the flame forms a small mushroom that reaches the up to the beginning of the oven cupola.

The flame must be soft, silent, blue at the base and yellow at the tip: you need to try to obtain a flame as yellow and as bright as possible, however stop before soot deposits on the cupola.

Flame F1 has to switch off only in the case where:

- the oven operator switches off the burner using the  “ON/OFF” red button;
- the oven exceeds the limit T° (set in factory at 450°C).
- intervention of the safety thermostat, vacuum “unsuitable environment”.



The adjustment criteria of flame F1 are:

- increase in the T° (to be avoided); operate on the gas adjustment screw, reducing its flow;
- amount of light produced;
- soot (to be avoided).



# FIRST IGNITION

## BLOCK / UNBLOCK BURNER

**DURING THE FIRST IGNITION, THE BURNER MAY GO INTO LOCKOUT.  
IN CASE OF BLOCK, THE SEQUENCE IS THE FOLLOWING:**



STEP	ACTION	PICTURE
1	The display shows the caption “bLoc” steady on. <b>Note:</b> the burner can attempt start-up 1 time before the “bLoc” caption appears on the green display.	
2	Then the burner block red led lights up.	

### BURNER RELEASE VIA “RESET” BUTTON

STEP	ACTION	PICTURE
1	Check that the green light of the ON-OFF button is on.	
2	Press the “RESET” button. Wait approximately 1 minute for the cycle to restart.	
3	If the problem persists, vent the gas pipe and then repeat the unlock procedure. If the problem is not solved, contact the technical service.	

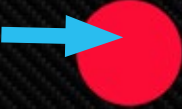

## BURNER RELEASE WITH “MAIN SWITCH” SIDE BUTTON

STEP	ACTION	PICTURE
1	Press the red “MAIN SWITCH” button (located on the left side) to cut off power to the burner.	
2	Press the red “MAIN SWITCH” button again (located on the left side) to return power to the burner. The burner will restart automatically.	
3	If the problem persists, vent the gas pipe and then repeat the unlock procedure. If the problem is not solved, contact the technical service	

# 34 kW BURNER

## INSTRUCTIONS FOR USING THE CONTROL UNIT

- Switch on the Easy Control unit by inserting the blue plug into an IEC 220 V, 16 A, 50 HZ socket. The displays light up; the red one indicates the oven internal temp while the green one indicates the set temperature. If it's the first ignition, 0°C appears on the display. To light the burner in the first flame setting, keep the SET button (N°3) pressed for 3 seconds. The green display flashes and shows 10°C; pressing the (N°4) button you can bump the first flame temperature up to the chosen one; if you release it, the temperature will be saved. Now, the display will automatically show the second flame temp, which will be 0°C at the first ignition. To light the burner, push the switch button (N°1); after a few seconds, the spark will trigger the lighting of the first flame and the corresponding LED (N°6).
- In the case of first ignition, the burner might lock out; then the LED is on (N°9). To unlock it, press the RESET button (N°10). The selector must be in the A (automatic) setting to prevent unwanted ignition of the second flame. To automatically light up the second flame, just push the (N°4) button and the desired temperature will appear on the green display and will be memorised. When the LED lights up (N°7) the second flame is on.
- Keep in mind that the first flame temperature must always be higher than the second flame one; the preset difference in the control unit is 10°C.
- Keep in mind that when the set temperature for the first flame is reached, the burner will switch off so this will be the maximum temperature attainable.
- Keep in mind that the temperature set for the second flame is the operating temperature of the oven to allow the burner to work with two flames. When the second flame set temp is reached, only the first flame stays on.
- This situation occurs when the amount of heat supplied by the burner with the first flame is the same as that needed by the empty oven to keep the first flame temperature; briefly, the temperature must neither rise nor fall.

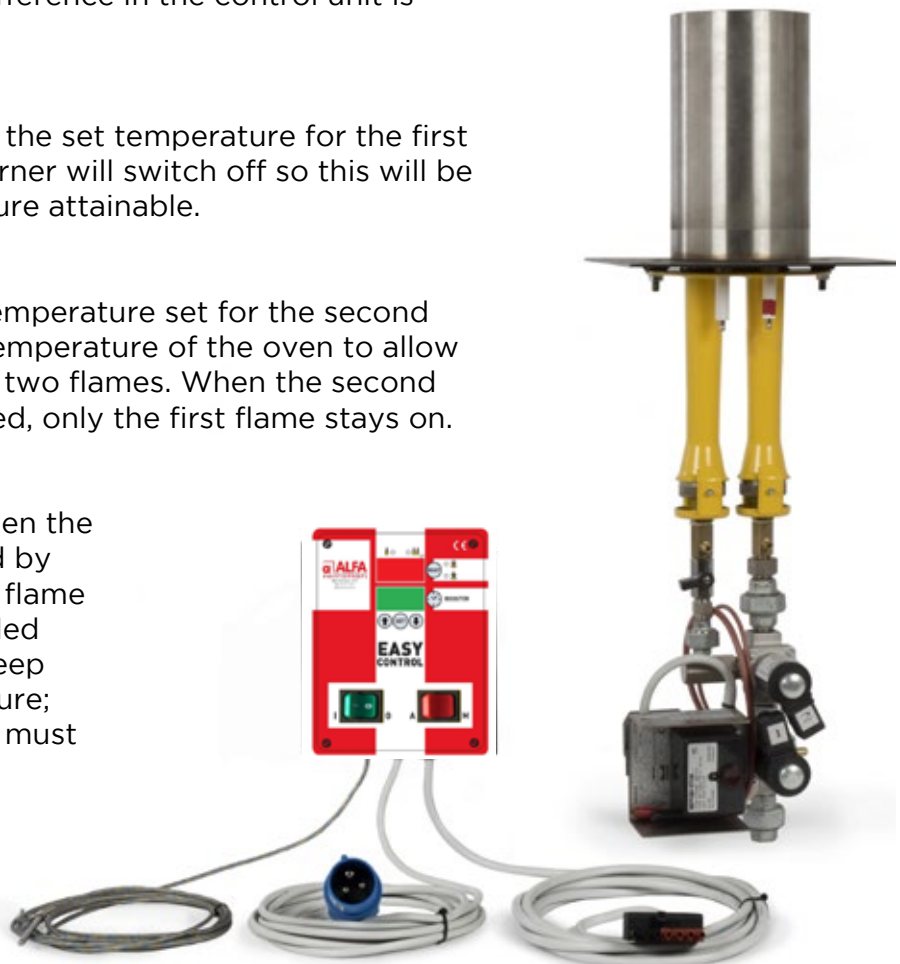

# INSTRUCTIONS FOR USING THE BOOSTER BUTTON





The “Booster” function activates the operation of the 2nd flame F2, at the moment when the oven has reached the set temperature and then switched off.

Once the time programmed in the “Booster” function has expired, the 2nd flame F2 starts to operate again in automatic mode.

The Booster function can only be activated once the oven has reached the set temperature and turned off the 2nd flame F2.

The 2nd flame F2 will not restart until the oven temperature drops to 7°C; in this 7°C range the Booster function can be activated.

The following procedure is used to program the duration of the “Booster” function:

STEP	ACTION	PICTURE
1	Press the “Booster” button.	
2	The programmable time for the Booster function appears on the green display.	
3	Press the “+” and “-” buttons to increase or decrease the “Booster” function duration with multiple times of 30 seconds.	
3A	Once the function is engaged, you can adjust the power of Flame F2 from 1 to 6 with the “-” and “+” buttons according to your needs. Once the flame power has been set, it will remain in memory for subsequent times.	
4	If necessary, turn off the Booster function by holding down the “Booster” button for a few seconds.	

# BURNER OPERATION WITH DAMAGED PROBE









## EMERGENCY PROCEDURE

### IMPORTANT!





The emergency procedure must remain active only until the temperature probe has been replaced; then, the normal burner operation must be restored.

In the emergency condition, being the temperature probe damaged or not working, it will not detect the temperature inside the oven.



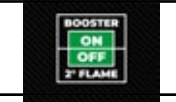

Proceed as follows to operate the burner with the probe damaged:

EMERGENCY PROCEDURE		
STEP	ACTION	PICTURE
1	Press the red "ON/OFF" button to ignite the burner in "ON" (the green "ON" LED lights up).	
2	Press and HOLD the "Booster" button.	
3	Press the "down arrow" button ONCE (always keeping the "Booster" button pressed).	
4	Press the "-" button ONCE. (always keeping the "Booster" button pressed).	
5	Press the "up arrow" button ONCE. (always keeping the "Booster" button pressed).	
6	Press the "+" button ONCE. (always keeping the "Booster" button pressed).	
-	The writing "SOS" appears on the red display.	
7	Release the "Booster" button.	





### BURNER IGNITION (with emergency procedure active)

STEP	ACTION	PICTURE
8	Press the "+" button ONCE..	
9	The low flame (within 5/10 seconds) and the corresponding LED light up.	
10	Press the "Booster" button.	
11	The high flame and related LED light up.	



12	Bring the oven to the desired temperature.	
10	Press the “Booster” button to turn off the high flame.	
11	The high flame and related LED go out.	
<b>BURNER SWITCH-OFF (with emergency procedure active)</b>		
<b>STEP</b>	<b>ACTION</b>	<b>PICTURE</b>
12	Press the “+” button ONCE to turn off the burner.	
-	<b>CAUTION!</b> DO NOT SWITCH OFF THE BURNER USING THE RED SWITCH “MAIN SWITCH” (on the left), OTHERWISE IT WILL BE NECESSARY TO REPEAT THE ENTIRE EMERGENCY PROCEDURE.	

## ERROR MESSAGES

COMMUNICATION	PICTURE
<b>BLOC:</b> burner locked	
<b>AL01:</b> probe fault	
<b>CC01:</b> Drago Control Plus control panel /modulating valve on burner fault	
<b>Err1:</b> the Drago Control Plus control panel plugs are not connected correctly	

COMMUNICATION	PICTURE
<b>---- (4 LINES):</b> probe fault	

# 34 kW BURNER

## CIRCUIT DIAGRAM

### ELECTRICAL CONNECTIONS

The power supply line must be interrupted by means of a 10 A bipolar circuit breaker with a 2 A fuse.

The connecting cables to the burner multiplug must have a section of at least 1,5 mm and must comply with the IEC 20-22 standards.

The burner must be earthed in accordance with the existing laws.

Do not reverse phase and neutral wires.

The hot parts of the oven must be kept away from power lines.

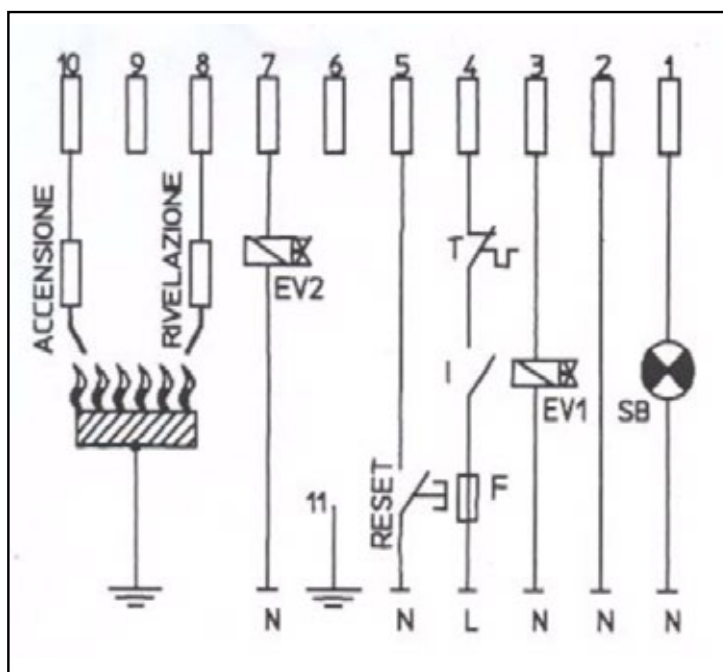

### EASY CONTROL UNIT DIAGRAM

- L** = Phase .
- N** = Neutral.
- 1** = Phase burner.
- 2** = Neutral burner.
- 3** = Reset.
- 4** = Lockout.
- 5** = Phase EV second flame.
- 6** = Return EV second flame.
- P** = Bridge for manual use.
- / +** = Thermostat probe.
- 0** = Automatic manual selector.

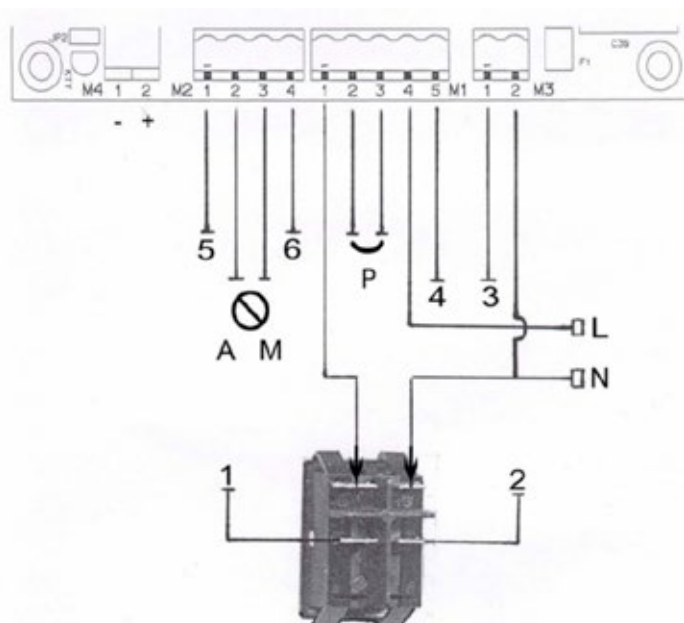



# CARE E MAINTENANCE

## **Chimney flue**

Before lighting the fire, make sure that the chimney flue is unobstructed (it should be inspected and cleaned once a year).



## **Cleaning ash**

Remove the ash from previous cooking with a brush and a dustpan.



## **Cleaning the oven floor**

When the oven is cold, clean the floor with a brush and wipe it with a damp cloth.



## **No chemicals**

Never use chemical products to clean the oven.



## **Never clean the oven when the floor is hot**

Do not wipe the oven floor with a damp cloth as it might cause it to crack.



# WARRANTY



ALFA professional ovens are covered by a legally-required 12-month warranty against conformity defects. Good maintenance and proper use of the product will contribute to extending its lifespan.

The time limit for reporting defects is 8 days from their discovery.

For legal warranty regulations, please refer to the provisions of the individual national legislation of reference.

**YOU ARE REQUESTED TO KEEP THE PURCHASE RECEIPT OR INVOICE TO SHOW TO THE RETAILER. WE ADVISE YOU TO WRITE DOWN BELOW THE SERIAL NUMBER YOU WILL FIND ON THE IDENTIFICATION LABEL ON THE BACK OF THE PRODUCT.**

**In case of any warranty claims, please contact your dealer only. Under the Warranty, ALFA undertakes to remedy any faults and malfunctions which are demonstrably related to material or manufacturing defects. ALFA shall be entitled to decide, on a case-by-case basis, whether to repair the product, to replace it or to substitute defective parts, without prejudice to business agreements and national legislation of reference.**

**We recommend the exclusive use of ALFA branded spare parts**





## **The warranty does not cover the following:**

Damage caused by the carrier in the event of such damage not being indicated immediately on the transport document by marking the product "accepted with reservation" upon receipt and immediately contacting the seller for further clarification;

The case of the oven not being properly used and installed as described in this manual. In particular, in the event of the oven needing to be recessed at the time of installation, please follow the correct procedures indicated in this manual under penalty of invalidating the warranty;

The case of the oven being tampered with in any way, whether intentionally or unintentionally, or altered so it is no longer in the condition it was when the product was delivered;

The case of damage to the product due to obstruction of all smoke/fume outlets;

Failure to observe the proper product maintenance and cleaning instructions as set out in the manual;

Damage to the burner due to cooking residues or damage in cases where fuel other than that recommended has been used, e.g. use of liquid barbecue charcoal, chemicals or other fuel;

The case of components being used which have not been manufactured or recommended by Alfa;

The case of damage being the result of the use of chemicals inside or outside the oven;

Damage due to exceeding the temperature indicated by the pyrometer provided, over 500°C (932° F), due to improper use of wood fuel;

The case of the label on the back of the product being removed, altered or erased;

The case of normal wear and tear of the product due to professional use;

Possible oxidation of the steel due to exposure to saline environments or near the sea.

Alfa specifies that possible oxidation is not due to quality defects in the product, but to intrinsic chemical-physical characteristics of steel in the event of prolonged exposure near saline environments;

Possible deterioration of the paint due to prolonged contact with flames;

Small surface imperfections on painted or aesthetic parts that do not affect the normal use of the product;

Accessory parts supplied with the product, such as the door;

Floors and underfloor insulation are not covered by the warranty. Alfa ovens are however supplied with a replacement floor;

As regards electrically powered products, the warranty does not cover light bulbs and any damage due to over voltage or the use of a power supply with inadequate power output and/or voltage;

The cost of the labour required to carry out the work under warranty.

